



**SUBJECT: TECO 930 - New universal wheel balancer**

Dear Sirs,

we are proud to announce that the new **TECO 930** universal wheel balancer for truck, bus, light commercial vehicle, and car wheels is now available for sale.

Available in motorised- or hand-spin versions.

Compact and lightweight. It is the most compact balancer in the whole range, featuring the most advanced programs available in top of the range models.

**IDEAL FOR MOBILE ROAD SERVICE AS WELL AS SMALL SIZE WORKSHOPS AND GARAGES**

**Bright digital display** with user-adjustable dual display for immediate and intuitive access to all programs and functions

**New generation measuring unit.**  
A **40 mm** shaft ensures precision and reliability



Hand driven **in-built wheel lifter** for effortless work without using the foot pedals. Can lift wheels weighing up to 150 kg ensuring the best wheel centring at all times



**MAIN FEATURES:**

- **Low balancing speed** (80 rpm truck / 100 rpm car) reduces spin times and lowers the risks connected with rotating elements, while also allowing for energy savings
- **Autoselettivo 2D internal sensor** for automatic acquisition of distance and diameter 28" with automatic selection of balancing programs
- **Virtual wheel width sensor.**
- **DYN, STATIC, ALU and ALUP** balancing programs available (adhesive weights on the inside of the rim)
- Three systems for attaching the adhesive counterweights are available:
  - **manual at 12 o' clock** (conventional method)
  - **manual at 6 o' clock**
  - assisted by **laser pointer at 6 o'clock** (optional)
- **Electric brake** with the motorised version or **pneumatic brake** with the hand spin version
- Special programs available as standard:
  - **Hidden Weight** for hiding the weights behind the spokes
  - **Imbalance Optimisation (OPT)** to minimise static wheel imbalance
  - **Multioperator**
- **Energy saving mode**
- **Software update via USB**

**EQUIPMENT**



**DIMENSION**

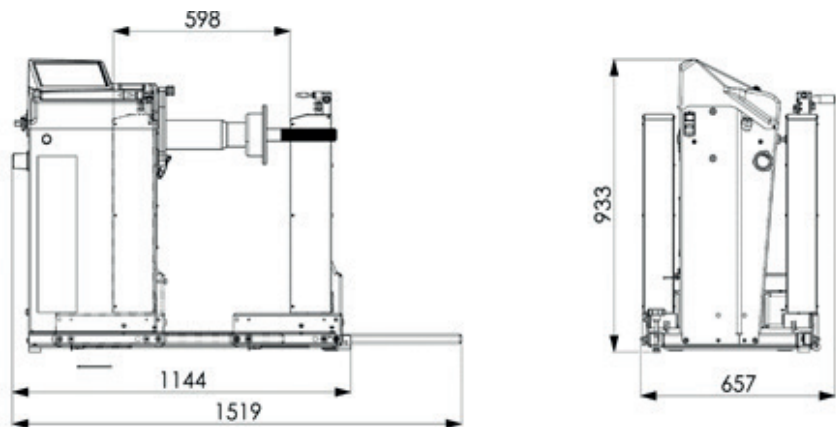







Full product details are provided below for correct product identification and accuracy of the order processing:



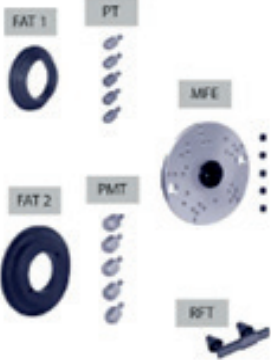

CODE	POWER SUPPLY	DESCRIPTION
0-21609300/16	200÷230V/1Ph/50-60Hz	<b>TECO 930 MO</b> WITH MOTORISED SPIN
0-21609301/16	200÷230V/1Ph/50-60Hz	<b>TECO 930 HS</b> WITH HAND SPIN



**RECOMMANDE ACCESSORIES**

	<p><b>GTR40 EVO</b> - Premium steel quick nut (suitable for TECO930 MOT)</p>	<p><b>8-21100275</b></p>
	<p><b>GTV40</b> -Basic ring nut (suitable for TECO930 MOT)</p>	<p><b>8-21900194</b></p>
	<p><b>GTM40</b> - Basic ring nut (only suitable for TECO930 HS)</p>	<p><b>8-21100272</b></p>
	<p><b>ART40 EVO</b> - Premium Heavy-Duty adaptor Kit for 10-8-6 holes</p>	<p><b>8-21100269</b></p>
	<p><b>KCT40 EVO</b> - Heavy-Duty cones kit - <math>\varnothing</math> 159 ÷ 180 mm/ 198 ÷ 204 mm - <math>\varnothing</math> 220 ÷ 281 mm</p>	<p><b>8-21100268</b></p>
	<p><b>ARU40 EVO</b> - Centering cones kit for car wheels <math>\varnothing</math> 42 ÷ 156 mm)</p>	<p><b>8-21900191</b></p>
	<p><b>L&amp;L KIT</b> - LASER &amp; LED KIT</p>	<p><b>8-21100238</b></p>



	<p><b>LASER BLADE KIT</b> - New accessory available to integrate a laser blade in the Autosel of the measuring detectors</p>	<p><b>8-21120022</b></p>
	<p><b>TRUCK TROLLEY KIT</b> for an easier handling of the wheel to calibrate</p>	<p><b>8-21101400</b></p>
	<p><b>ROLL-BAR KIT</b> - Safety roll-bar</p>	<p><b>8-21101401</b></p>
	<p><b>ACCESSORY RACK</b> - Accessory holder</p>	<p><b>8-21101402</b></p>